

Uniden®

iGO CAM 325 **Accident CAM** **Vehicle Recorder**

For more exciting new products please visit our website:
Australia: www.uniden.com.au

OWNER'S MANUAL

Important Safety Instructions



NOTE

Uniden does not represent this product to be waterproof. Do not expose this product to Rain or Moisture.



NOTE

This product is intended for use in a motor vehicle. Don't install the device where it will block the driver's view of the road (including the mirrors!) or the deployment of the airbag.



NOTE

Keep your attention on the road! Don't try to operate or focus on any device while driving. If you have to concentrate on a device, pull off the road for a few minutes.



NOTE

Ensure that the camera lens is kept clean and there is nothing blocking the lens.



NOTE

Don't leave the device in direct sunlight for a long period of time or where the temperature could go above 60°C.

CONTENTS

Important Safety Instructions	2
What Do I Do First?	4
Make Sure These Items Arrived in the Box	4
Controls & Indicators	5
How Do I Put It in My Car?	7
Attaching the Windshield Mount	7
Operation	8
Micro SD Card	8
Plug it in, Power On/Off	9
Record Mode	10
Photo Mode	12
Playback Mode	13
Connecting to a PC	13
Settings Menu	14
Important Information	15
Warranty	16

What Do I Do First?

Make Sure These Items Arrived in the Box



iGO CAM 325



Windshield Mount



DC (CAR) Adaptor



USB Cable

- Owner's Manual

- If any item is missing or damaged, contact your place of purchase immediately. ***Never use damaged products!***
- Need help? Get answers at our website: ***www.uniden.com.au*** for Australian model.

Controls & Indicators

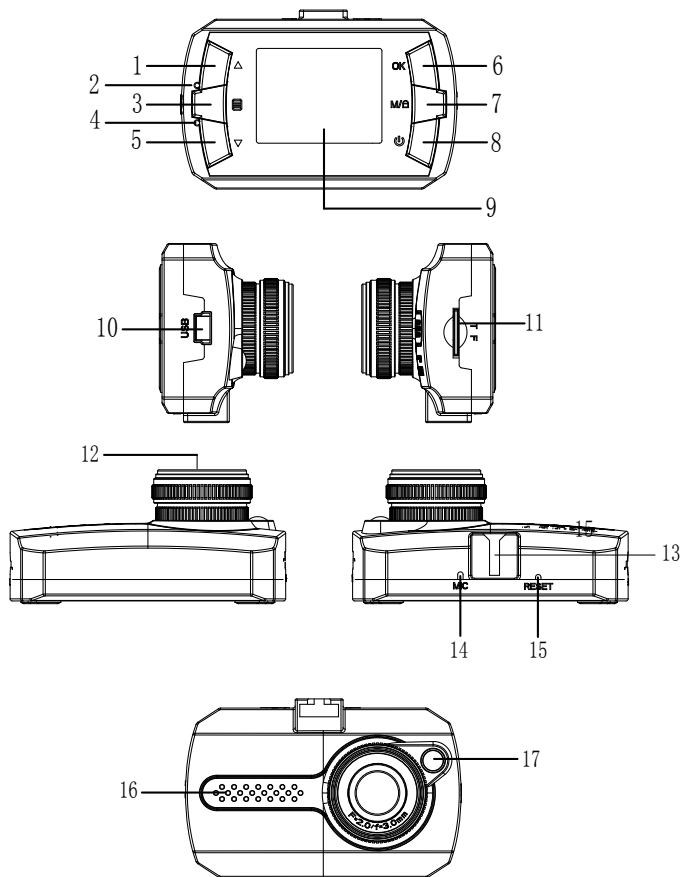

Ref	Component	Description
1	UP ▲	<ul style="list-style-type: none"> In Menu list, move the cursor, one line up.
2	LED	<ul style="list-style-type: none"> RED - Indicates charging
3	MENU ☰	In standby, open the Menu.
4	LED	<ul style="list-style-type: none"> BLUE - (Glow) Standby (Flashing) recording
5	DOWN ▼	<ul style="list-style-type: none"> In Menu list, move the cursor, one line down Turn on/off the audio recording.
6	OK	<ul style="list-style-type: none"> In the Record mode, press this button to start/stop video recording. Use this button to capture an image in the Photo mode. Help confirm a menu selection. Confirm changes in the settings.
7	M/ 🔒	<ul style="list-style-type: none"> While recording, press to lock/save (from overwrite) the current recording. Use this button to shift between the Record, Photo and Playback mode.
8	POWER	<ul style="list-style-type: none"> Press to turn power on. Press & hold to turn power off. During power on, press to turn Infrared LEDs (night vision) on/off.
9	LCD	
10	USB Port	<ul style="list-style-type: none"> Connect External Power & charge battery Connect to PC for data (SD card) transfer
11	Card Slot	micro SD Card Slot
12	Lens	
13	Bracket Slot	Fit the bracket hook of the windshield mount
14	MIC	Records sound.
15	Reset	If the device fails to operate, try resetting the device. Press the reset button using a fine pen or paperclip.
16	Speaker	
17	Infrared LED	LED for night vision

How Do I Put It in My Car?

Attaching the Windshield Mount

1. Insert the bracket hook into the bracket slot provided on the top of the unit.
2. After inserting the hook, slide it down till it locks in position.
3. Press the suction cup flat against the windshield.
4. Push the suction lock up, until it snaps into place and tighten the locking collar to secure.
5. Gently pull on the mount to make sure it is secure.



NOTE

Suction cups will not stick well on a curved/textured or wet surface.

Operation

Micro SD Card



NOTE

A compatible micro SD card (not supplied) is required to record and store videos and photos.

The unit can support micro SDHC cards (High Capacity SD) up to 32GB in capacity. A micro SDHC card of at least 4GB capacity and minimum Class 4 speed is recommended.

Insert a formatted micro SD card gently in the slot at the side of the unit. To remove the card from the slot, press the edge of the SD card inwards for it to pop out and then pull it out of the slot.

Uniden recommends using good quality micro SD cards.

Battery Information

Although primarily designed for in-car use, the unit can operate from its built-in battery for up to 10 minutes.

Please note, the power usage would depend on day/night recording and resolution setting.

The unit will charge the battery whenever power is detected through the USB port. When the unit is being charged, the Red LED will glow. It will automatically turn off when the unit has been charged completely. The unit will take about 90 minutes to charge completely.



NOTE

Please ensure that the battery is fully charged before using it for the first time. To extend the battery life, fully charge the unit once every 3 months.

Battery Alert

The image given below indicates the battery level at different stages.



Empty



Low



Half full



Full

Plug it in, Power On/Off



NOTE

When connected to a car charger with power, the unit will automatically power on and start recording.

1. Connect the DC car adaptor to the power connector (USB port) found on the device.
2. Connect the other end of the DC car adaptor to your car's cigarette lighter.
3. When connected to the car charger the unit will power on automatically and start recording. When the car's engine is turned off, the unit will automatically turn off in a few seconds.

At other times, press the  Power button to turn it on, or press & hold the Power button to turn it off.



NOTE

Only use the DC car adaptor that comes with your device. Any other adaptor might damage the device.

Record Mode



NOTE



To record a video, ensure that a valid SD card (not supplied) is inserted in the given slot. Also note, that inserting/removing the SD card when the unit is recording causes the device to shutdown.

Recording

When connected to a car charger, the unit automatically goes into the record mode and starts recording. The  icon will display on the screen.

A flashing red dot next to the  icon indicates that the unit is recording. To stop recording, press OK and the red dot disappears, indicating that the recording has stopped.

Protect Function to Protect the Current Recording

If you want to protect the current recordings, then press the **M/**  button, the  key icon will appear on the screen. This indicates that those recordings have been locked and will not be overwritten by new video clips.

Menu Settings



NOTE

Please note, you cannot access MENU when the the unit is recording. To access the Menu, you will need to stop recording by pressing OK.

In the record, photo or playback mode, press the MENU button once to access the menu settings for that particular mode. Press twice to display the Settings menu. Press the relevant UP and DOWN keys to scan through the various settings and then press OK to select.

Press the MENU button to exit the Menu.





















<p>Resolution</p> 	<p>Set the video resolution. The maximum resolution is 1080P.</p>
<p>Loop Recording</p> 	<p>Use this option to set the time duration for each recording. If you choose the option 'Off' then the recorder will not loop record and the files will not be overwritten on the micro SD card. The duration of these recorded files will be around 10 minutes.</p>
<p>Exposure</p> 	<p>Set the brightness sensitivity.</p>
<p>Motion Detection</p> 	<p>Enable this setting to allow the recorder to start recording when it detects movement.</p>
<p>Record Audio</p> 	<p>Use this setting to turn on/off the audio recording.</p>
<p>Date Stamp</p> 	<p>Use to display or hide the date and time stamp on the recordings.</p>
<p>G-Sensor</p> 	<p>This feature detects significant or sudden movement and automatically locks the current recording.</p>
<p>Key Tone</p> 	<p>Have the keys sound a tone when you press them.</p>
<p>Parking Mode</p> 	<p>Parking Mode is off by default. You can switch it on to allow G-Sensor to detect strong vibration and start recording for the parked vehicle.</p>



Photo Mode

- Press the MODE button till you see the  icon displayed on the top left corner of the screen.
- Now, press the OK button to take a photo.

Menu Settings

Timer 	Set the time gap for capturing an image. For example, if you select 2s, then that will be the delay between the OK button being pressed and the image being captured.
Resolution 	Define the image resolution.
Sequence 	The camera goes into a continuous shooting mode when this option is activated and you get up to 5 shots in one click.
Quality 	Use to define the quality of the images you want to capture.
Sharpness 	Use to define the clarity of detail in the images you want to capture.
White Balance 	Establish the condition to capture an image, from the options given.
ISO 	Use this setting, to increase or decrease the sensitivity of the camera towards light.
Exposure 	Set the brightness sensitivity.
Anti-Shake 	Activate this to reduce the camera shake and capture a better quality image.
Date Stamp 	Enable/Disable the date and time on the image files.

Playback Mode

- Press MODE button till you see either of the  or  icons displayed on the top left corner of the screen.
- Press the UP and DOWN keys to scan through the various video/image files.

When in the Playback mode, press the MENU button to get the following options:

- Delete
- Protect

Delete

Select this setting by using the relevant UP/DOWN key and press OK. The following options are displayed on the screen - Delete Current, Delete All. Choose the option, based on whether you want to delete the current file or all the files (both recordings and images) on the SD card.

Protect

Select this setting by using the relevant UP/DOWN key and press OK. The following options are displayed on the screen - Lock Current, Unlock Current, Lock All, Unlock All. Choose the option, based on whether you want to lock/unlock the files on the SD card, and then press OK.

Connecting to a PC









The iGO CAM 325 can be connected to a PC (using the supplied USB cable).

When the unit is connected to the PC, the following options - Mass Storage, PC Camera - are displayed on the unit's screen.

Select the option Mass Storage to manage and view the SD card contents on the PC. When the unit is detected on the PC as an external drive, select to view the DCIM folder. Click on the DCIM folder to open and view recordings/images arranged in folders according to the specified date. The locked/protected recordings have file names beginning with 'SOS', thus enabling you to easily distinguish them from the rest of the recordings.

Settings Menu

In any of the modes (record, photo or playback), press the Menu button twice to open the settings menu.

Set Date/Time 	Change the date and time by using the relevant UP and DOWN keys, and then press OK to confirm.
Auto Power Off 	Set the time duration to automatically power off the unit, when idle.
Language 	Set the language.
Frequency 	Under this setting you have the option to choose between 50Hz or 60Hz. Select the relevant option and press OK.
Screen Saver 	Set the time to automatically turn off the LCD after the recording starts.
Format 	Use this option to format the SD card
Default Setting 	Use this option to change all the settings back to the default factory settings.
Version 	Firmware Version

Important Information

Solving Problems

Listed below are some of the problems and the possible solutions. If you still need help, visit our website, listed on the front cover.

General Problems	Possible Solutions
The unit cannot take photos or record videos The unit automatically stops when recording	<ul style="list-style-type: none">• Ensure that the SD card is formatted properly and inserted correctly.• Use the recommended type of SD card (minimum 4GB Class 4)
Video is unclear	Ensure that there are no fingerprints or dirt on the lens. Ensure that the lens is always kept clean.
Dark images while recording water/sky	Adjust the EV setting.
Colour of the images is not good	Set the 'white balance' setting to automatic.
Cross-stripe interference in an image	This is due to the light frequency. Change the light frequency depending on the local power supply.
The unit crashes	Press and hold the 'Reset' button, with a pin, to restart the unit.

Warranty

UNIDEN iGO CAM 325

IMPORTANT: Satisfactory evidence of the original purchase is required for warranty service

Please refer to our Uniden website for any details or warranty durations offered in addition to those contained below.

Warrantor: The warrantor is Uniden Australia Pty Limited ABN 58 001 865 498 ("Uniden Aust").

Terms of Warranty: Uniden Aust warrants to the original retail purchaser only that the iGO CAM 325 ("the Product"), will be free from defects in materials and craftsmanship for the duration of the warranty period, subject to the limitations and exclusions set out below.

Warranty period: This warranty to the original retail purchaser is only valid in the original country of purchase for a Product first purchased either in Australia or New Zealand and will expire one (1) year from the date of the original retail sale.

If a warranty claim is made, this warranty will not apply if the Product is found by Uniden to be:

- (A) Damaged or not maintained in a reasonable manner or as recommended in the relevant Uniden Owner's Manual;
- (B) Modified, altered or used as part of any conversion kits, subassemblies or any configurations not sold by Uniden Aust;
- (C) Improperly installed contrary to instructions contained in the relevant Owner's Manual
- (D) Repaired by someone other than an authorized Uniden Repair Agent in relation to a defect or malfunction covered by this warranty; or
- (E) Used in conjunction with any equipment, parts or a system not manufactured by Uniden.

Parts Covered: This warranty covers the Product and included accessories.

User-generated Data: This warranty does not cover any claimed loss of or damage to user-generated data (including but without limitation phone numbers, addresses and images) that may be stored on your Product.

Statement of Remedy: If the Product is found not to conform to this warranty as stated above, the Warrantor, at its discretion, will either repair the defect or replace the Product without any charge for parts or service. This warranty does not include any reimbursement or payment of any consequential damages claimed to arise from a Product's failure to comply with the warranty.

Our goods come with guarantees that cannot be excluded under the Australian Consumer Law. You are entitled to a replacement or refund for a major failure and for compensation for any other reasonably foreseeable loss or damage. You are also entitled to have the goods repaired or replaced if the goods fail to be of acceptable quality and the failure does not amount to a major failure.

This warranty is in addition to and sits alongside your rights under either the COMPETITION AND CONSUMER ACT 2010 (Australia) or the CONSUMER GUARANTEES ACT (New Zealand) as the case may be, none of which can be excluded.

Procedure for obtaining warranty service: Depending on the country in which the Product was first purchased, if you believe that your Product does not conform with this warranty, you should deliver the Product, together with satisfactory evidence of your original purchase (such as a legible copy of the sales docket) to Uniden at the address shown below. You should contact Uniden regarding any compensation that may be payable for your expenses incurred in making a warranty claim. Prior to delivery, we recommend that you make a backup copy of any phone numbers, images or other data stored on your Product, in case it is lost or damaged during warranty service.

UNIDEN AUSTRALIA PTY LTD

Phone: 1300 366 895

Email: custservice@uniden.com.au

Uniden[®]

© 2018 Uniden Australia Pty Limited.
Printed in PRC V1.1